

OptiCool®

An abstract graphic composed of thick, overlapping red and white curved shapes. The shapes create a sense of depth and movement, with some areas appearing to be cut away or layered. The overall composition is dynamic and modern.

OptiCool System
and Configurations



Product Description

Quantum Design's OptiCool is a magneto-optical cryostat that builds on our 40+ years of experience developing and manufacturing automated temperature and magnetic field control platforms. The innovative cryostat and magnet design puts the sample in the heart of your optical environment. This highly integrated design means, even with a magnet, your sample isn't buried inside a large cryostat, far away from the optics. Seven side optical ports, one top optical port, and an optional bottom optical port allow for optical access to your sample from a wide array of directions.

Every aspect of the OptiCool has been developed to provide the largest range of sample access, while also ensuring that the system is easy to use. Utilizing and adapting DynaCool's successful approach to cryocooler equipment design, the system requires only a small volume of helium gas for its fully automated startup and operation.

Magnetic Design & Control

The OptiCool comes with a new superconducting, split-coil, conical magnet that has been custom designed by Quantum Design for this platform. This large bore magnet offers fields perpendicular to the optical table up to ± 7 tesla. The system includes a hybrid digital/analog magnet controller designed for precise, quiet control of the magnetic field. The bipolar design also allows smooth continuous ramping through zero field.

Temperature Control

Quantum Design customers have come to expect easy-to-use automated temperature control. OptiCool delivers on this promise with a unique, single-cooler design that provides cooling for both the magnet and the circulating helium. This system provides seamless transitions throughout its temperature range of 350 K to 1.7 K, and stable operation at its base temperature of 1.7 K.

Fully Automated Operation

Included with the OptiCool is custom control software that automates the operation of the cryostat. The cryostat can be cooled down and warmed up with a click of the mouse, requiring no user intervention. Changing the sample temperature or applied magnetic field is also fully automated. The software also allows you to graph and analyze your data in real time to quickly see trends and features. LabVIEW and Python interfaces are included to allow you to control the instrument within your existing measurement software.

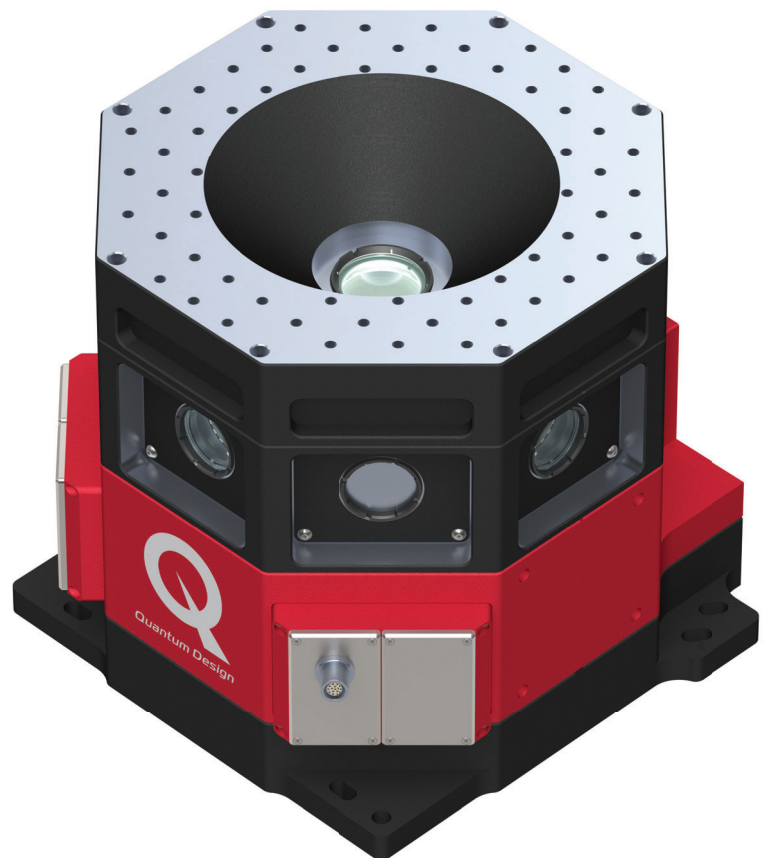

*A History of Innovation
8 Optical Access Ports
1.7 K to 350 K; ± 7 tesla
Cryogen Free
Automated Operation*

*Only be limited
by your imagination...*

Optical Access & Sample Space

OptiCool leverages state-of-the-art magnet and cryostat design to offer an excellent combination of optical access and magnetic field range. This unique magnet allows the sample space to be accessed by up to nine optical ports – one top, seven side, and an optional bottom port – all within a magnetic field range of ± 7 tesla. There is ample space for close working distance microscope objectives within ambient or vacuum environments. With a numerical aperture of >0.7 for the top port and >0.11 for side ports, OptiCool provides a wide variety of optical angles and magnetic field variations. In addition, the 89 mm (diameter) by 84 mm (height) sample volume offers lots of space for your experimental hardware inside the cryostat vacuum.

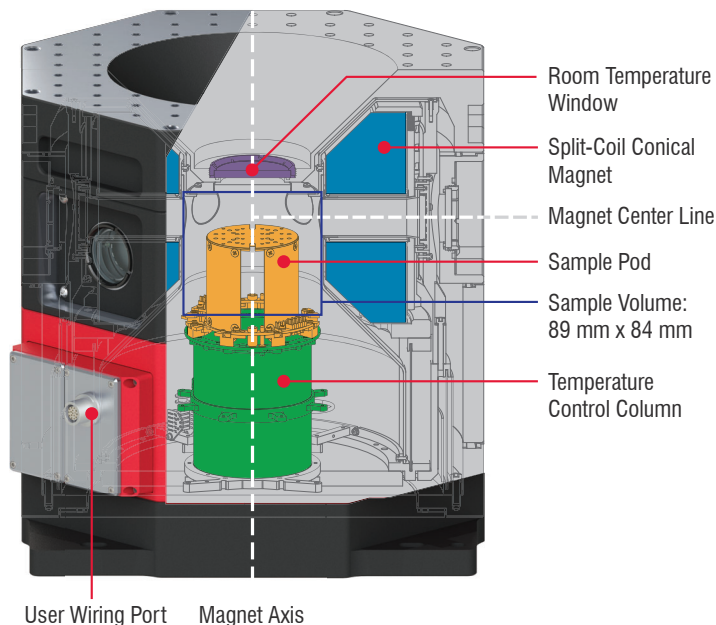

Cutaway of OptiCool Cryostat showing sample pod, sample space and magnetic axis and center.

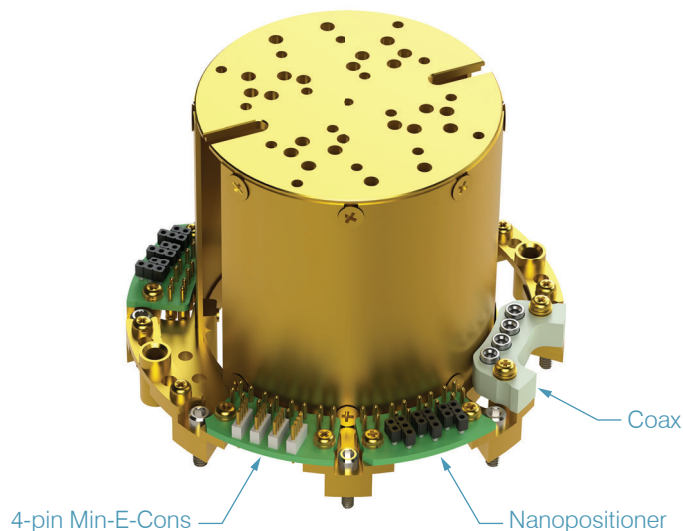

OptiCool sample pod showing sample surface and prewired sample boards available.

Sample Pod & Wiring Possibilities

OptiCool's removable Sample Pod provides a place to build and customize your experiment on the bench. Wire your experiment to wiring bays on the pod. When you are ready to make a measurement, the Sample Pod easily plugs into the temperature control column, which thermally anchors the wiring and routes it to the outer User Wiring Ports. When your measurement is finished, the pod is easily swapped with another pod, already wired up with your next experiment. OptiCool contains 5 wiring bays, each of which can be configured with 16 twisted pairs for typical user signals, 3-axis positioner wiring for sample nanopositioning, or 4 RF coaxial lines for signals up to 20 GHz. Optical fiber feedthroughs are also available.

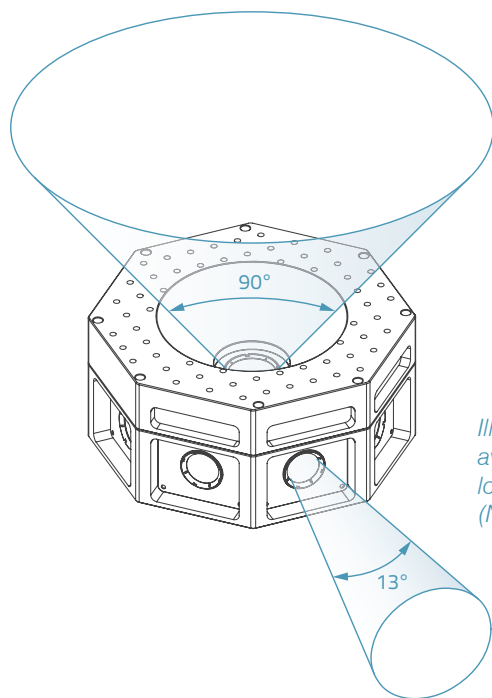

Illustration of OptiCool Cryostat demonstrating optical access angles available through 8 optical ports. Top window ($NA > 0.7$; 90° for sample located 13 mm above magnetic center) and 7 side windows ($NA > 0.11$; 13° for sample located at magnetic center).

OptiCool® Specifications*

Temperature Control

Temperature Range:	1.7 K to 350 K
Temperature Stability:	±0.2% for T < 20 K; ±0.02% for T > 20 K
System Cooldown Time:	17 hours (typical)

Magnetic Field Control

Maximum Field:	±70,000 Oe (±7 T)
Field Uniformity:	±0.3% over a 3 cm diameter spherical volume

Optical Access

Access Port Details:	8 total access ports standard
1 top and 1 optional bottom window:	50 mm diameter, 41.5 mm clear bore (user-replaceable)
7 side windows:	40 mm diameter, 24.5 mm clear bore (user-replaceable)
Acceptance Angle, Top Window:	70 degrees full angle: Sample located at magnet center
	90 degrees full angle: Sample located 13 mm above magnet center
Acceptance Angle, Side Window:	13 degrees full angle: Sample located at magnet axis
Microscopy Options:	Low working distance top window for 3mm spacing (vs 15mm standard) between ambient and sample; Vacuum objective mounting hardware for in-vacuum room-temperature or cryogenic objectives

Vibrational Stability

Horizontal:	< 10 nm peak-to-peak
Vertical:	< 4 nm peak-to-peak

Sample Space

Maximum Sample Volume:	89 mm diameter by 84 mm tall
Sample Environment:	Sample in cryostat vacuum space

Dimensions

Optical Table:	Cryostat Footprint: 1 m x 0.5 m (minimum) Cryostat Height: 1 m (minimum)
Floor Space:	Tower Footprint: 0.75 m x 0.75 m Tower Height: 2 m (minimum) Cabinet (not shown) Footprint: 1 m x 1 m Cabinet (not shown) Height: 0.68 m (minimum)

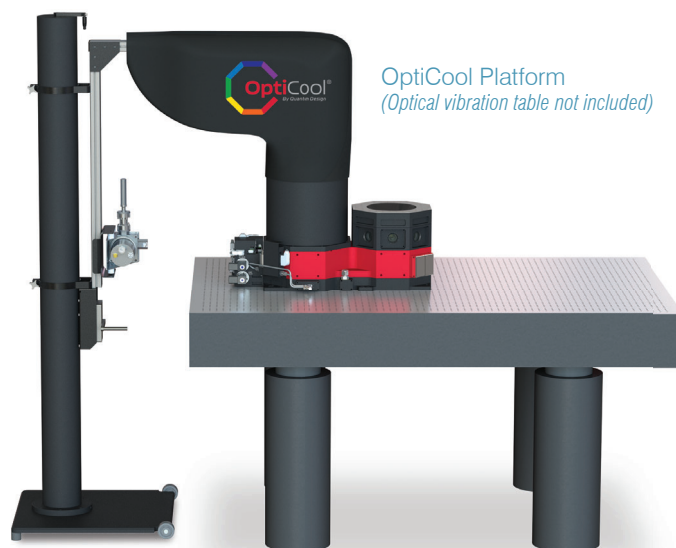

OptiCool Platform
(Optical vibration table not included)

Optical Sample Pods

Swapping out samples and experiments is easy and convenient using OptiCool's Sample Pod technology. The removable pod provides you a place to build and customize your experiment on the bench. When you are ready to make a measurement, the pod easily plugs into the pre-wired Sample Column, connecting all the experimental wires at once. Having multiple experiments arranged on multiple pods allows you to switch experimental hardware quickly. Sample pods are available in both a standard configuration and a large-volume configuration, depending on your experimental needs.

Configuring the Sample Pods

Samples and experimental hardware are attached to the pod via the Mounting Plate. The mounting plate has a 4x4 grid of imperial #4-40 tapped holes (shown in red below) as well as other common hole patterns for mounting piezo positioners. This plate is replaceable and can have custom holes added if desired. Slots in the mounting plate make it easier to route wires to your hardware and reduce eddy current heating during magnet ramping.

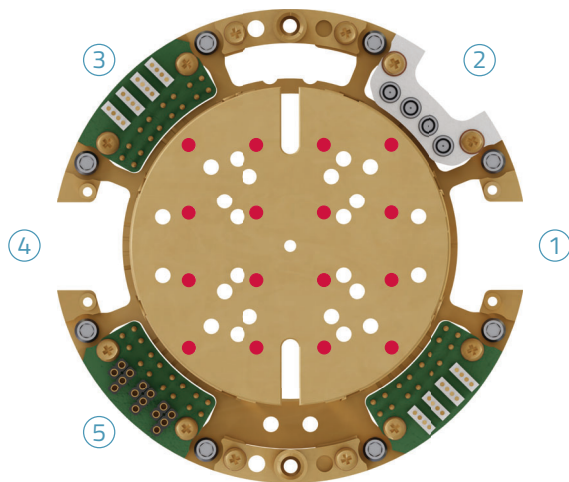

Top down view of sample pod showing 5 available bays for connector boards. In this image, bay 2 shows RF coax connectors, bay 3 shows standard sample wiring connectors, and bay 5 shows nanopositioner connectors installed on pod.

Connecting Wires to Your Sample

Each Sample Pod has 5 bays available to mount connector boards. The bays need to be configured to match the pre-installed wiring configuration of your OptiCool. Once properly configured, the connector boards mate up with the OptiCool wiring when the Pod is installed. Each different type of board presents a connector on the top side of the Pod Flange to extend the wires to your sample. Mating connectors for each board style installed in the system are included with the OptiCool. For more information regarding available pre-wired options, see the *OptiCool Wiring and Feedthrough Options* section on page 6.

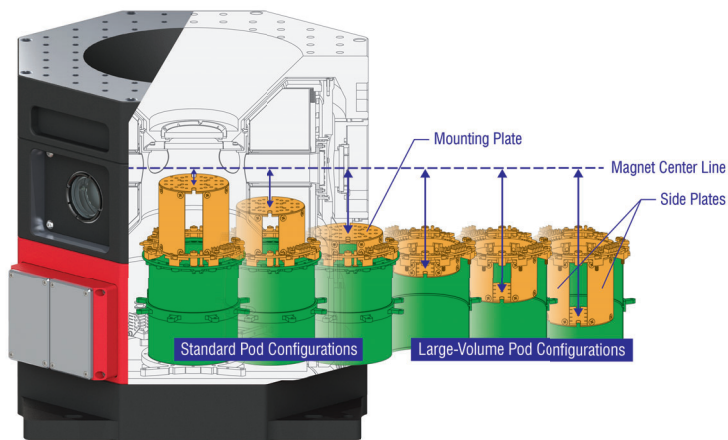

X100 – Standard Sample Pod

X110 – Large-Volume Sample Pod

The removable Sample Pod, which is available in either a standard or large-volume configuration, allows you to position the mounting plate at six different locations within the sample volume. The location of the mounting plate relative to the Magnet Center Line can be adjusted by swapping out the two curved side plates that are attached to the pod (see below). The three available side plate pairs allow you to locate the mounting plate at either 12.4 mm, 32.8 mm, 56.4 mm, 87.4 mm, 111 mm, or 131.3 mm below the magnet center line position.

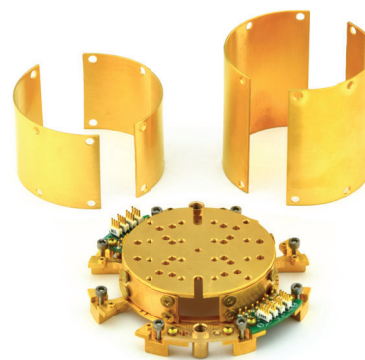

The sample pod is available in standard and large volume configurations. The standard configuration is useful for mounting smaller experimental setups or samples higher up in the sample volume. The large-volume configuration (below) is useful for mounting tall experimental setups or including more complex stacks of positioners while keeping the sample in the center of the magnetic field.

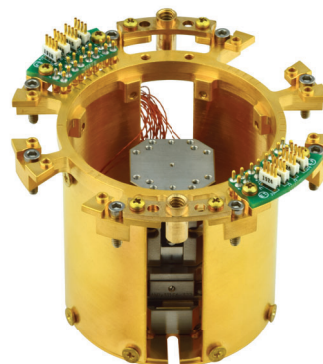

OptiCool Sample Positioner and Mounting Options

X130 - Integrated Nanopositioners (Includes X132 Thermal Link)

The OptiCool cryostat can be configured with a piezo-based nanopositioning stack to move your sample in-situ over the full range of temperature and magnetic field. The X130 Integrated Nanopositioner option with position-feedback provides full X, Y, and Z motion control and knowledge of your sample position.

The nanopositioner stack, comprised of two attocube ANPx311 stages and one ANPz102 stage, provides a travel range of 5.8 mm in the X and Y directions and 4.8 mm in the Z direction for focusing. The resistive position-feedback has a resolution of 200 nm and a repeatability of 1 to 2 μm . This allows you to consistently go back and find features of interest on your sample. The stages can also be run in fine positioning mode with a range of 0.8 μm (X and Y) at 4K with sub-nm resolution. The X130 includes spacers to vary the vertical stack location by 14 mm to accommodate a variety of experiment needs.

X132 - Thermal Link

Quantum Design has created a custom Thermal Link for use with Integrated Nanopositioners. The Thermal Link effectively cools your sample while providing full mobility for linear positioner motion in X, Y, and Z. The high-A/L design is optimized for cooling at high magnetic fields where magnetoresistance reduces the effectiveness of other high-RRR thermal links. The Thermal Link comes with a built-in thermometer to give you an accurate temperature reading close to your sample without impacting clearance. The X132 Thermal Link is included with the X130 Integrated Nanopositioners or it can be purchased separately for use with other positioner stacks.

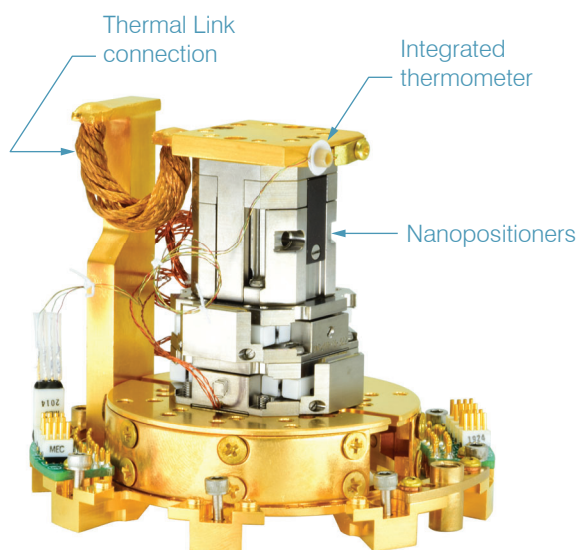

Image shows the X130 Integrated Nanopositioners with the X132 Thermal Link option and integrated thermometer.

X140 - Rapid Thermal Stage

Many experiments in OptiCool require x-y positioning of the sample to locate a region of interest, and z positioning to focus a microscope objective lens on the sample. To reduce the effect of thermal drift on focus, the X140 Rapid Thermal Stage (RTS) controls the temperature of a small button where the sample is mounted, while maintaining the rest of the components at low temperature. This results in focus shift of $< 30 \mu\text{m}$ over the temperature range 1.8 to 350 K.

In addition to helping you maintain focus, the RTS changes temperature very quickly due to its small size. Temperature changes that would normally take hours are accomplished in < 30 minutes.

The Rapid Thermal Stage includes an integrated thermometer and heater located directly under the sample button for accurate temperature measurement and control (you can read this temperature through MultiVu).

Samples can be mounted directly to the Rapid Thermal Stage button, or to one of the easy-to-install Disk Mounts included with option.

The Rapid Thermal Stage is designed to be cooled by the Quantum Design X132 Thermal Link. The RTS may be compatible with other thermal links (although each case would need to be determined individually).

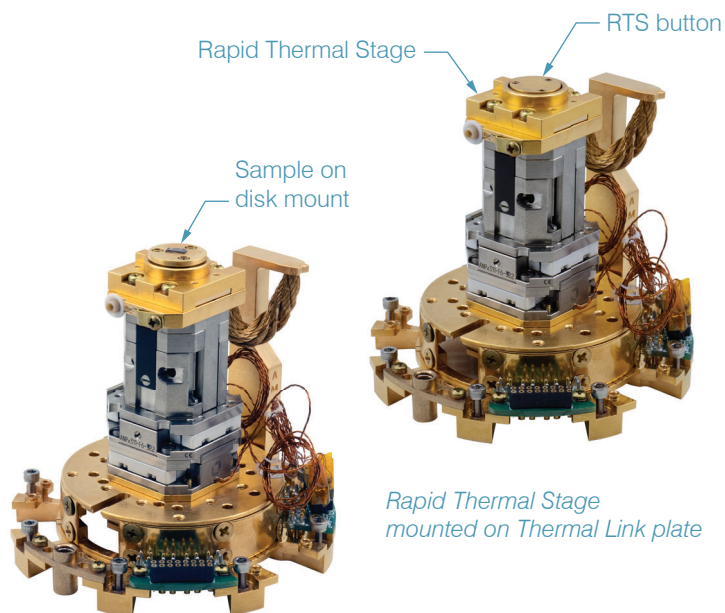

* Specifications when mounted to Quantum Design X132 Thermal Link:

• Temperature range:	1.8 K to 350 K
• Focus shift over temperature range:	$< 30 \mu\text{m}$ (sample mounted directly to button) $< 35 \mu\text{m}$ (sample mounted to 1.4 mm thick disk mount)
• Temperature sweep times (disk mount installed):	2 K to 300 K: < 6 minutes 300 K to 2 K: < 30 minutes

X150 - Wired Sample Mount Kit

Optical measurements often require electrical contact (for gating and transport measurements) while focusing a microscope objective on the sample.

The Wired Sample Mount provides a gold-plated copper plane that is thermally connected to the X132 Thermal Link plate and provides 16 pre-wired pads for connecting electrical leads to your sample. Unlike standard chip carriers, the mount's copper plane makes metallic contact through solid copper to the Thermal Link plate – this will typically cool mounted samples to within < 50 mK of the Thermal Link temperature.

An integrated flexible circuit carries the 16 wires to the pod flange. The Wired Sample Mount is designed to be used with OptiCool's Standard Sample Wiring (X300).

The Wired Sample Mount Kit includes 4 Wired Sample Mounts, the mating PC board that goes on the Pod flange, and the associated mounting screws.

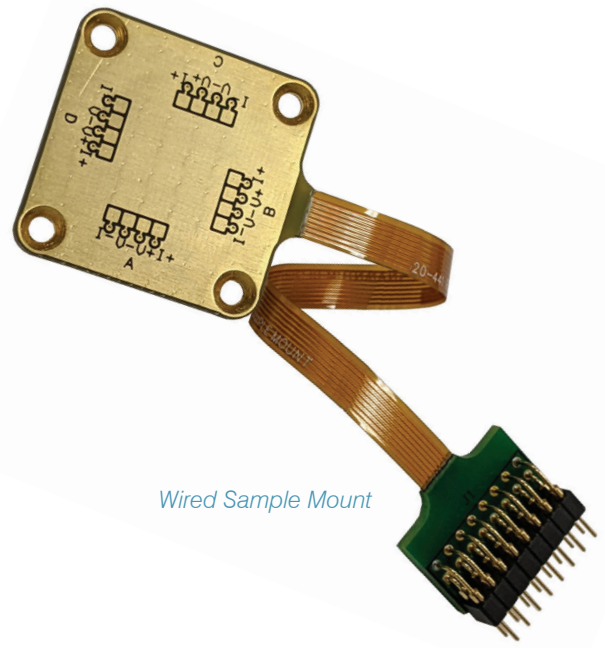

Wired Sample Mount

* Specifications:	
• Compatible with full OptiCool temperature and magnetic field range	
• Mounts to X132 Thermal Link Plate and compatible with X140 Rapid Thermal Stage	
• Electrical connections:	16 connections (8 pairs) Pads for wire bonding or soldering Pads arrange in 4 four-probe sets Automatic connections from pads to OptiCool front panel (no manual wiring)

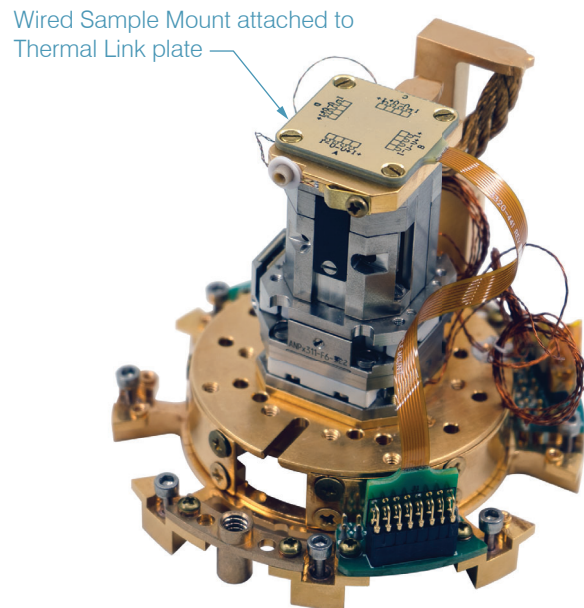

OptiCool Wiring and Feedthrough Options

Wiring and feedthrough options are available to get electrical and optical signals into and out of the OptiCool cryostat. Pick from these options to meet your experimental needs. Each is described in more detail on the following pages.

- **X300 Standard Sample Wiring.** 16 wires (8 twisted pairs) for user signals.
- **X301 3-Axis Positioner Wiring.** Used to drive piezo positioners.
- **X310 RF Coax Wiring.** Four coax lines for signals up to 20 GHz.
- **X280 Optical Fiber Feedthrough.** Feed four or more optical fibers into the sample volume. Can also be used for other items such as gas tubes.

The wiring options are permanently mounted in the cryostat, so are usually installed at the factory. The fiber feedthrough is easily installed or removed by the end user.

To use the wiring, simply wire from the pod connectors to your hardware. When the pod is inserted into OptiCool, connections are automatically made to the cryostat wiring (fiber connections must be made manually). The signals then run from your experiment to the OptiCool front panel. All the wiring is thermally anchored inside the cryostat, ensuring the wires will not disrupt your sample's temperature.

Please contact Quantum Design to discuss the best wiring combination for your needs.

X300 – Standard Sample Wiring

Standard sample wiring provides 16 wires (8 twisted pairs) for many uses, including resistance measurements, I-V curves, and gating. It may be possible to drive positioners using these wires, but if you know you will need positioners, be sure to include X301 positioner wiring. Twisted pairs are typically useful up to tens of kHz. If you use higher-frequency signals, see X310 RF coax wiring.

- Configuration: 16 wires (8 twisted pairs) for user signals
- External connector: 16-pin Fischer connector. Mating cable connector provided.
- Mating cable available for purchase: 3318-404-01 adapts from the Fischer connector to a standard DB-25 connector.
- Pod connector: four 4-pin Min-E-Con connectors. Mating connectors with solder pins are provided.

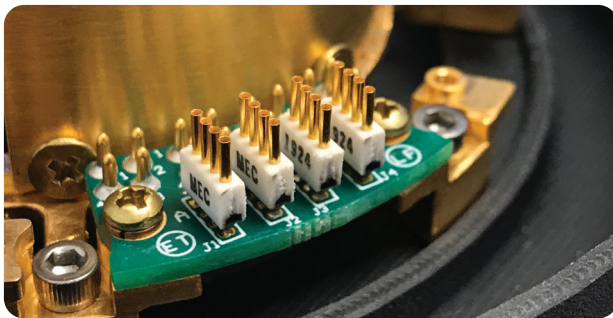

- Wire info: Eight 36-gauge (0.13 mm) phosphor-bronze twisted pairs (16 wires)
- Wire resistance: 5 Ohms (typical) from Fischer to Min-E-Con
- Maximum Voltage: 150 V

X301 – 3-Axis Positioner Wiring

Positioner wiring is optimized for piezo-driven nanopositioner stacks. This wiring is compatible with attocube stages with or without /RES feedback. It can drive 3 positioners with /RES feedback or 6 positioners without feedback.

- Configuration: 3 pairs of low-resistance piezo drive wires and 3 sets of signal wires for /RES feedback.
- External connector: 16-pin Fischer connector. Mating cable connector provided.
- Mating cables: the following cables that mate with the Fischer connector can be purchased for use with this wiring:
 - 3318-401: Connects to attocube controller cables for up to 3 positioners with /RES feedback
 - 3318-403: Connects to attocube controller cables for up to 6 positioners without feedback

- Pod connector: 2 mm headers (three 2-pin and three 3-pin). Attocube positioners connect directly to these as shown below. Mating connectors with solder pins are provided for connecting other positioners.

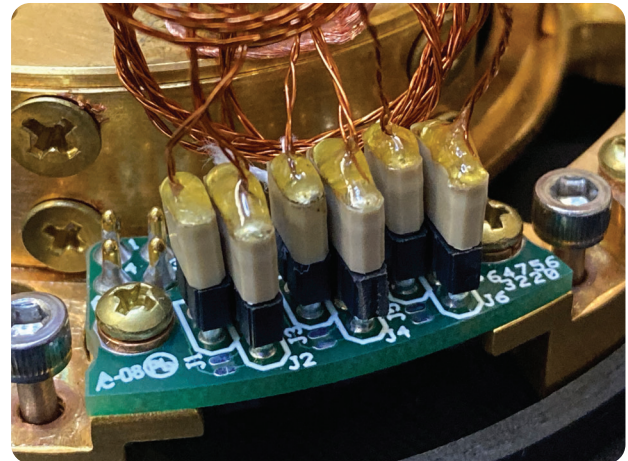
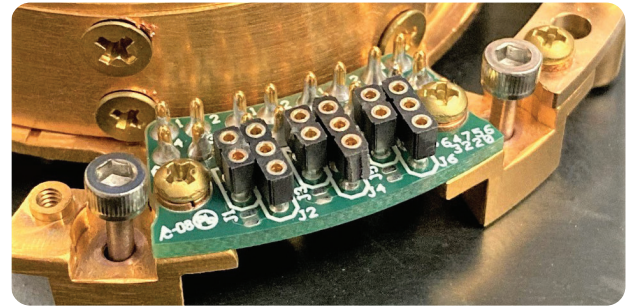

- Wire info:
 - Three pairs of drive wires for driving piezo positioners.
 - Three sets of signal wires (3 signals each) for /RES resistive position feedback. User configurable to drive up to 3 more piezo positioners instead.
- Wire Resistance:
 - Drive wires: 0.8 Ohms (typical) from Fischer to Min-E-Con
 - Signal wires: 5 Ohms (typical) configured for resistive feedback; 2.5 Ohms (typical) configured to drive piezo positioner.
- Maximum Voltage: 150 V

X310 – RF Coax Wiring

RF coax wiring provides four RF lines for use up to 20 GHz. Like other wiring options, you make connections from your sample to the pod. When you plug the pod into the cryostat, the pod connectors mate to the permanently installed (and thermally anchored) coax lines in the cryostat. There is no need to make coax connections by hand inside the cryostat.

- Configuration: Four RF coax lines for signals up to 20 GHz
- External connector: SMA

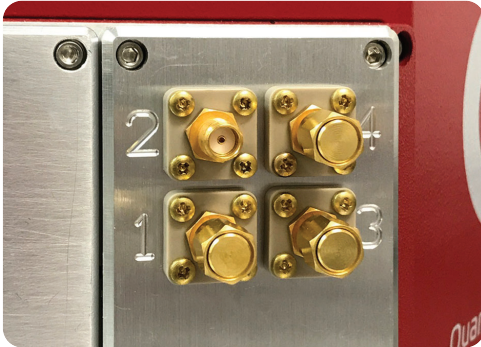

- Pod connector: SMPM (Mini SMP)

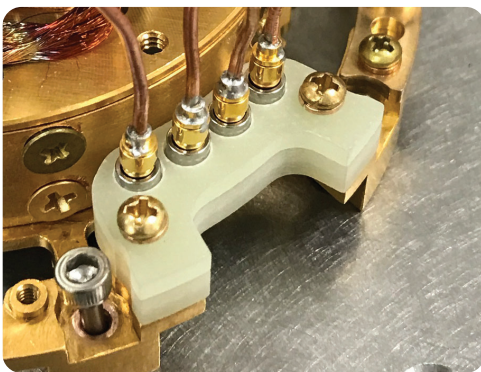
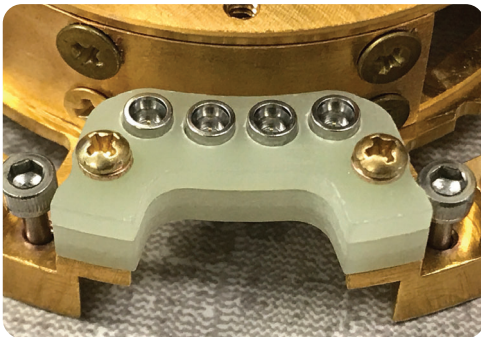

- Coaxial Wires: Four .047 inch (1.19 mm) semi-rigid copper-nickel coax
- Isolation: All coax lines and RF connectors isolated from cryostat ground (inner and outer conductors)
- Maximum Voltage: 325 VRMS
- Maximum attenuation from front panel to pod connector:

0.5 GHz	1.6 dB
1.0 GHz	2.1 dB
5.0 GHz	4.3 dB
10 GHz	6.0 dB
20 GHz	8.3 dB

X280 – Optical Fiber Feedthrough

The optical fiber feedthrough kit makes it easy to feed optical fibers from outside the cryostat to your experiment on the OptiCool Sample Pod. The kit provides four 1/8-inch compression fittings with Teflon ferrules designed for 125 μm fibers. Simply insert a fiber through a ferrule, then tighten the compression nut to achieve a vacuum tight seal. With no fiber-connector interfaces, light loss is minimized.

The kit includes an interface to the OptiCool thermal shield to cool the fibers to <50 K before routing to your sample. This ensures that your experiment reaches OptiCool's low base temperature (1.7 K).

If your fibers are too large to fit in the existing ferrule holes, you can simply drill out the holes. You can add extra holes to install more than one fiber in each of the four compression fittings.

The feedthrough kit can be used with any item that is compatible with 1/8-inch Swagelok compression fittings. For example, a gas membrane-controlled Diamond Anvil Cell (DAC) typically uses a 1/16-inch gas tube, which can be installed using a 1/8 to 1/16-inch compression adapter. This uses only one of the four compression fittings, so the other three are still available for fibers or other uses.

The feedthrough kit is easily installed by the user in their laboratory. One pair of side windows (vacuum and shield) are removed, then the feedthrough hardware is installed in their place. Any of the seven side window locations can be used.

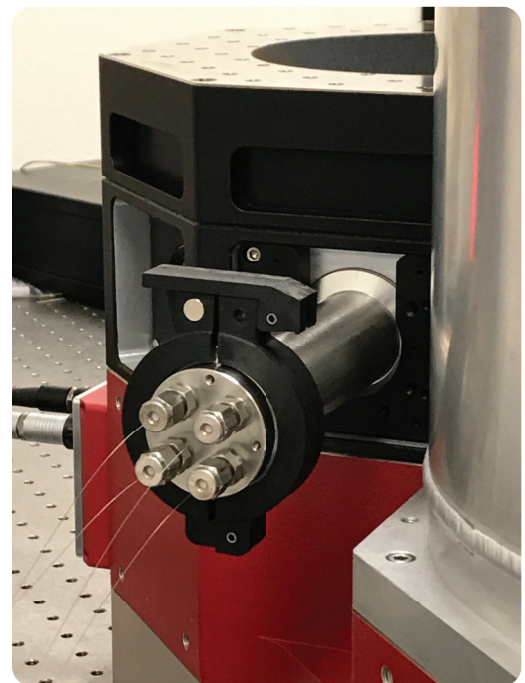

Fiber feedthrough installed in location of one side window.

OptiCool Windows and Objectives

X210 – Low Working-Distance Top Window

A low working-distance (LWD) top window is available for use with external microscope objectives. The standard OptiCool top windows have a minimum working distance of about 15 mm between the top of the outer window and the underside of the inner shield window. With the LWD top window, this distance can be reduced to about 3 mm. This close spacing is achieved with a 0.75 mm thick outer window and a 0.40 mm thick inner window. The outer window is UV fused silica and is epoxied into the window frame to create a low profile, low stress, durable seal. The inner window is also UV fused silica and is held in place with spring clips that minimize stress in the glass at low temperatures and allow for easy replacement or removal. Both windows have a thickness tolerance of ± 0.01 mm and together have a combined thickness of 1.15 mm. This thickness of fused silica matches the optical thickness of 1.10 mm of crown glass, a common correction thickness available in many objectives. The windows can be ordered uncoated, with a 650-1050 nm AR coating, or with a 400-800 nm AR coating. Also, Zinc Selenide windows (both 1 mm thick) are available for use in the Mid-Infrared.

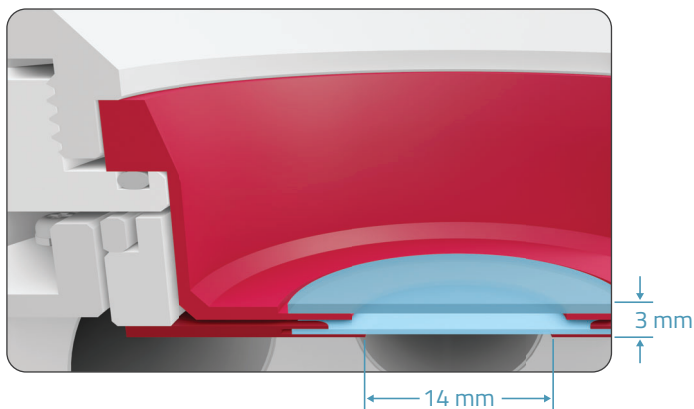

Installed Low Working Distance Window with 0.75 mm-thick outer window and 0.40 mm-thick inner window.

The clear window diameter at the shield is 14 mm and, because of the high homogeneity of the magnet, the field error across the full diameter at the window is less than 0.3%. While the shield window is required for the ultimate base temperature of your sample, you can remove the shield window if base temperature is not critical. A spacing less than 1 mm can be achieved between the outside of the cryostat and your sample if the shield window is removed.

Above the window, you can directly mount objectives at close spacing using the included flared window clamp. The clamp has standard Thorlabs SM3 ID threads allowing an objective to be mounted using off-the-shelf adaptor rings. This clamp can be removed and adjusted while the system is cold and under vacuum, allowing the use of multiple objectives during a single cooldown.

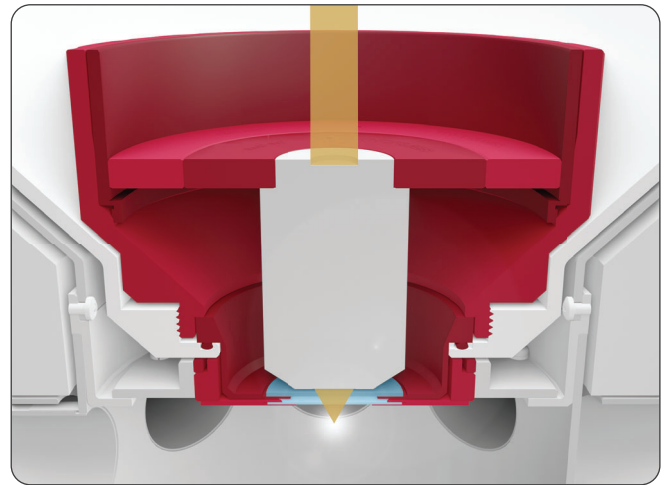

Cross-sectioned view of the flared window clamp with adapter rings and an external objective mounted close to the window.

X200/X202 – Internal Microscope Objective

Many experiments require a high-quality, high-NA objective positioned close to the sample. To address this need, Quantum Design offers two vacuum compatible objective options. The **X200** option has a 0.75 NA Zeiss 100x LD EC Epiplan-Neofluar objective with a working distance of 4 mm, giving a free working distance of 3 mm between your sample and the cold shield aperture. The **X202** option has a 0.9 NA Zeiss 100x EC DIC Epiplan-Neofluar objective with a working distance of 1 mm. Use this option where maximum light gathering is a priority. When used with the X201 Mounting Hardware (included), these objectives are maintained in vacuum at room temperature to provide the optimal environment to take full advantage of their high-performance designs.

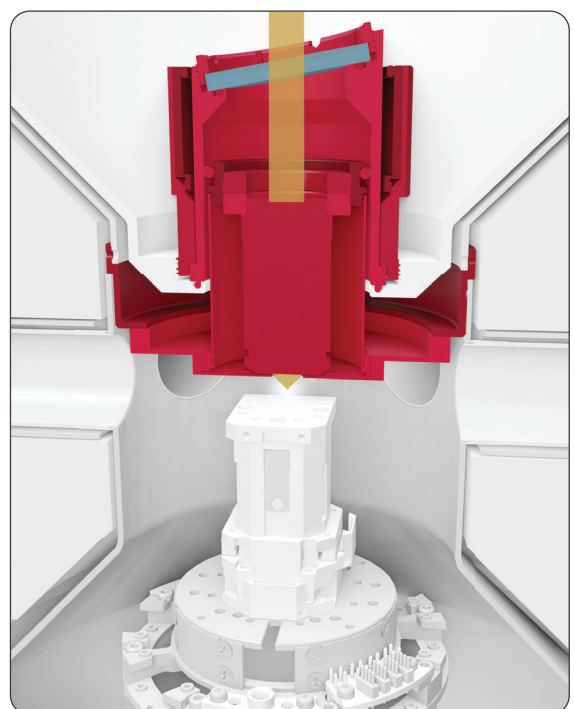

Zeiss objective and nanopositioners in a cross-sectioned view of the OptiCool sample volume.

X201 – Internal Objective Mounting Hardware

Quantum Design offers the hardware from the X200 and X202 options (see page 9) without the objective as a separate kit so you can mount your own objectives. The hardware is highly configurable to allow many different types of objectives to be installed. The mounting hardware can be configured to maintain the objective at room temperature or to cool it to shield or sample temperature for the lowest possible working distance. You can mount a room temperature objective in vacuum using either an orifice for the best optical performance, or a shield window for the lowest base temperature. With a cold objective, both the lowest base temperature and highest NA are possible. Non-magnetic, vacuum compatible objectives are recommended for room temperature mounting, and cryogenic compatible objectives for cold mounting.

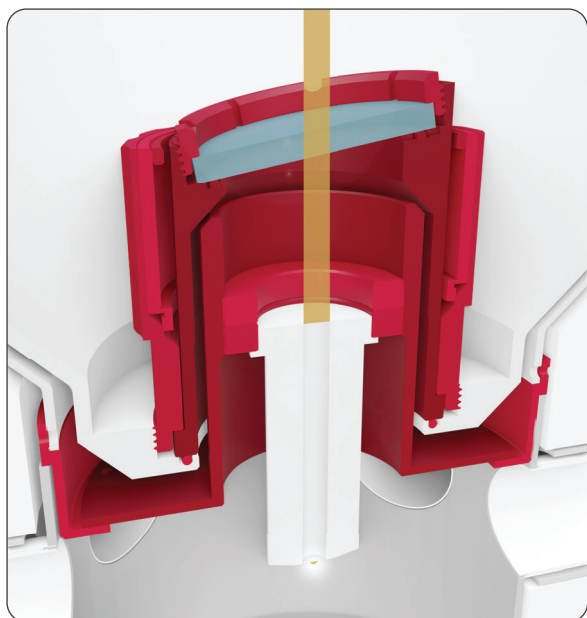

Mounting hardware allowing use of customer's own "top window" objectives.

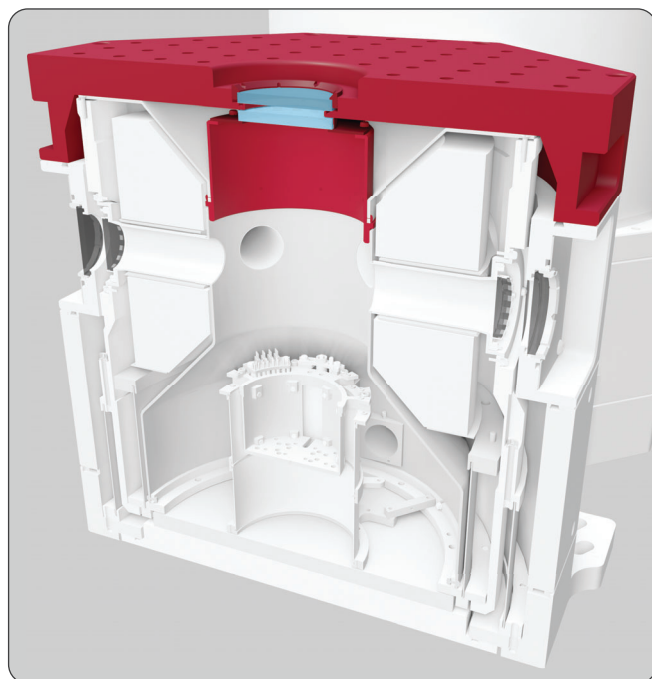

Cross-sectioned view of the OptiCool cryostat showing the Large Top-Volume Housing Kit installed. This provides an additional 57 mm of overhead beyond the standard sample volume.

X242 – Cryostat Riser

The cryostat riser is a rigid platform that lifts the cryostat 175 mm above the surface of the optical bench. Use the X242 Cryostat Riser to gain access to the bottom window. This riser is included with the X240 Bottom Access Window option.

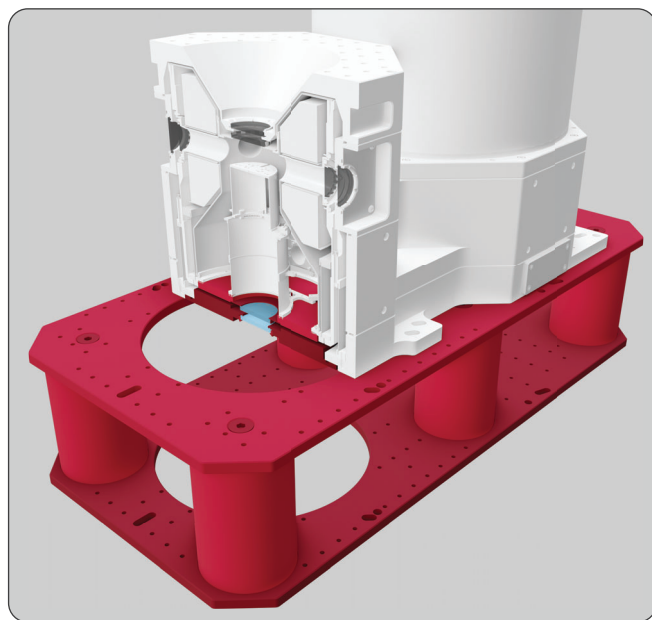

OptiCool cryostat equipped with bottom window mounted on top of the riser platform.

X245 – Large Top-Volume Housing Kit

The cryostat's top vacuum housing and shield adapter can be replaced to create additional space in the sample volume. With this kit the top window is moved up 57 mm to provide extra volume above the magnet center line for additional experimental hardware or optical components.

X240 – Bottom Access Window

A bottom window can be added to the OptiCool cryostat allowing transmission measurements along the magnet-axis, perpendicular to the surface of the optical table. This option replicates the top window interface within the bottom vacuum plate and shield plate, allowing use of the same windows and hardware. This option along with the top window allows for a 41 mm diameter clear volume through the center of the cryostat. This option includes the X242 Cryostat Riser for gaining access to the bottom window.



Quantum Design

Quantum Design, Inc.
10307 Pacific Center Court, San Diego, CA 92121
Tel: 858.481.4400 Fax: 858.481.7410
www.qdusa.com
sales@qdusa | apps@qdusa

*For complete specifications, contact your local Quantum Design office.
Specifications subject to change without notice. 1318-016 Rev. C0